

di-GPS®
Eco ProFessional 2
(PF-2)
digital images GPS receiver

User Guide

Ver 1.3

Please visit our website www.di-gps.com for the latest version of user guide

CONTENTS

CONTENTS	1
INTRODUCTION	2
WARNING / PRECAUTION FOR USE (I)	3
WARNING / PRECAUTION FOR USE (II)	4
PART NAMES OF ECO PF-2 GPS	5
CONNECTING ECO PF-2 GPS AND REMOTE CONTROL SOCKET	6
POWER SUPPLY.....	7
POWER MODE BUTTON	7
RECORDING GPS DATA (I)	8
RECORDING GPS DATA (II)	9
LAST POSITION MEMORY (LPM)	10
SPECIFICATIONS.....	11
WARRANTY.....	12
EUROPEAN UNION DECLARATION OF CONFORMITY.....	13
EUROPEAN UNION DECLARATION OF CONFORMITY (II)	14

DI-GPS® IS A REGISTERED TRADEMARK OR A TRADEMARK OF DAWN TECHNOLOGY LIMITED.
NIKON D5, D4, D4S, D3, D3S, D3X, D500,D810A, D810, D800, D800E, D700, D300, D300S, D2XS, D2X, D2HS, D200 D5600, D3400, D7200, D5500, D3300, DF, D5300, D610, D600, D750, D7100, D7000, D5100, D5000, D3200, D3100, D90 ARE REGISTERED TRADEMARK OR A TRADEMARK OF NIKON CORPORATION IN THE UNITED STATES AND/OR OTHER COUNTRIES.
FUJIFILM AND S5 PRO ARE REGISTERED TRADEMARK OR A TRADEMARK OF FUJIFILM U.S.A., INC. IN THE UNITED STATES AND/OR OTHER COUNTRIES.

INTRODUCTION

Thank you for purchasing **di-GPS®** ECO ProFessional 2 (PF-2) GPS Receiver (digital images GPS).

di-GPS® ECO ProFessional 2 (PF-2) GPS Receiver (hereafter “ECO PF-2 GPS”) is specially designed for DSLR (Digital Single-lens Reflex) cameras, providing real time position (latitude, longitude, elevation) and the precise time (UTC time) information. It records the location to each digital image file so that exact locations where photos are taken will never be forgotten.

ECO PF-2 GPS is built with the latest third generation MTK MT3339 ultra low power consumption GPS engine. It supports up to 66 channels of satellite with -165dBm sensitivity. Equipped with state-of-the-art technology, ECO PF-2 GPS has achieved an extremely fast TTFF (Time-To-First-Fix), unrivaled high sensitivity and superior performance in virtually any outdoor environment. Even when no GPS signal is available or when the unit is out of GPS coverage, real UTC date/time with the last fixed position will still be recorded to provide most accurate location data possible.

ECO PF-2 GPS receiver can work in places where GPS was not possible before: in the woods, under dense foliage, canyons, terrain obstructions, in densely populated cities with high-rise buildings and even inside trains or cars, with no external antenna required. It is scrupulously designed to meet the accelerating demand of digital photographers nowadays.

DI-GPS® IS A REGISTERED TRADEMARK OR A TRADEMARK OF DAWN TECHNOLOGY LIMITED.

NIKON D5, D4, D4S, D3, D3S, D3X, D500, D810A, D810, D800, D800E, D700, D300, D300S, D2XS, D2X, D2HS, D200, D5600, D3400, D7200, D5500, D3300, DF, D5300, D610, D600, D750, D7100, D7000, D5100, D5000, D3200, D3100, D90 ARE REGISTERED TRADEMARK OR A TRADEMARK OF NIKON CORPORATION IN THE UNITED STATES AND/OR OTHER COUNTRIES.

FUJIFILM AND S5 PRO ARE REGISTERED TRADEMARK OR A TRADEMARK OF FUJIFILM U.S.A., INC. IN THE UNITED STATES AND/OR OTHER COUNTRIES.

V1.3

WARNING / PRECAUTION FOR USE (I)

- Keep out of reach of children. This device contains small parts that may pose a choking hazard. Consult a physician immediately if a child swallows any part of this device.
- Under no circumstances should you attempt to disassemble the product and repair it yourself. Doing so may result in electric shock or product malfunction. Should the product break open as the result of a fall or other accidents, send the unit back to Dawn Technology Limited for inspection. For more information, please visit our website at www.di-gps.com.
- Do not handle with wet hands or immerse in or expose to water or rain. Failure to observe this precaution could result in fire or electric shock.
- Do not use in the presence of flammable gas. Failure to observe this precaution could result in explosion or fire.
- Do not expose to flame or excessive heat.
- Do not expose to high temperatures.
- Do not leave the device in closed vehicle under the sun or in other areas subject to extremely high temperatures. Failure to observe this precaution could result in fire or in damage to the casing or internal parts.
- Turn off immediately in the event of malfunction. Should you notice smoke or unusual smell coming from this device, remove the GPS unit immediately and send the unit back to Dawn Technology Limited for inspection. For more information, please visit our website at www.di-gps.com.

DI-GPS® IS A REGISTERED TRADEMARK OR A TRADEMARK OF DAWN TECHNOLOGY LIMITED.

NIKON D5, D4, D4S, D3, D3S, D3X, D500, D810A, D810, D800, D800E, D700, D300, D300S, D2XS, D2X, D2HS, D200, D5600, D3400, D7200, D5500, D3300, DF, D5300, D610, D600, D750, D7100, D7000, D5100, D5000, D3200, D3100, D90 ARE REGISTERED TRADEMARK OR A TRADEMARK OF NIKON CORPORATION IN THE UNITED STATES AND/OR OTHER COUNTRIES.

FUJIFILM AND S5 PRO ARE REGISTERED TRADEMARK OR A TRADEMARK OF FUJIFILM U.S.A., INC. IN THE UNITED STATES AND/OR OTHER COUNTRIES.

V1.3

WARNING / PRECAUTION FOR USE (II)

Important WARNING

Do not put the camera into the bag with the GPS at the bottom (as shown in the picture below). Failure to prevent that may cause permanent damage to the GPS unit and/or the camera's terminal.



Remove ECO PF-2 GPS from the camera if it is not going to be used in a long period of time to reduce chance of damage during movement of camera.

DI-GPS® IS A REGISTERED TRADEMARK OR A TRADEMARK OF DAWN TECHNOLOGY LIMITED.

NIKON D5, D4, D4S, D3, D3S, D3X, D500, D810A, D810, D800, D800E, D700, D300, D300S, D2XS, D2X, D2HS, D200, D5600, D3400, D7200, D5500, D3300, DF, D5300, D610, D600, D750, D7100, D7000, D5100, D5000, D3200, D3100, D90 ARE REGISTERED TRADEMARK OR A TRADEMARK OF NIKON CORPORATION IN THE UNITED STATES AND/OR OTHER COUNTRIES.

FUJIFILM AND S5 PRO ARE REGISTERED TRADEMARK OR A TRADEMARK OF FUJIFILM U.S.A., INC. IN THE UNITED STATES AND/OR OTHER COUNTRIES.

V1.3

PART NAMES OF ECO PF-2 GPS

A – Power Mode Button / LED

B – GPS status LED

C – Connector to DSLR camera

D – Locking nut

E – 10-pin remote terminal cover

F – 10-pin remote terminal

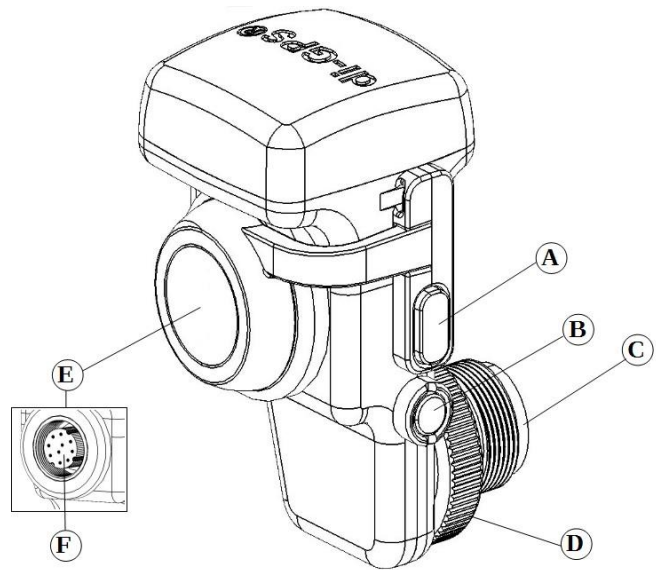

DI-GPS® IS A REGISTERED TRADEMARK OR A TRADEMARK OF DAWN TECHNOLOGY LIMITED.

NIKON D5, D4, D4S, D3, D3S, D3X, D500, D810A, D810, D800, D800E, D700, D300, D300S, D2XS, D2X, D2HS, D200, D5600, D3400, D7200, D5500, D3300, DF, D5300, D610, D600, D750, D7100, D7000, D5100, D5000, D3200, D3100, D90 ARE REGISTERED TRADEMARK OR A TRADEMARK OF NIKON CORPORATION IN THE UNITED STATES AND/OR OTHER COUNTRIES.

FUJIFILM AND S5 PRO ARE REGISTERED TRADEMARK OR A TRADEMARK OF FUJIFILM U.S.A., INC. IN THE UNITED STATES AND/OR OTHER COUNTRIES.

V1.3

CONNECTING ECO PF-2 GPS AND REMOTE CONTROL SOCKET



Attach the strip to the eyelet of the camera.

Insert the ECO PF-2 GPS to the 10-pin remote terminal of the DSLR camera body.

Tighten the locking nut.



An optional Nikon remote control accessories (MC-30, MC-36) can be connected to the 10-pin remote terminal of the ECO PF-2 GPS for remote shutter release.

- Remove the 10-pin remote terminal cover before using the Nikon remote control accessories.

NOTE

- ECO PF-2 GPS cannot be turned on when it is not connected to the camera.
- Please refer to the user manual of your DSLR for more information on taking photograph with a GPS receiver.
- Please make sure the camera is turned off before disconnecting ECO PF-2 GPS. Do not connect or disconnect ECO PF-2 GPS while the camera is on. Failure to observe this precaution could cause a malfunction of the camera.
- Do not carry the camera by ECO PF-2 GPS or subject the camera or the unit to physical shocks while the unit is connected. Failure to observe this precaution could result in physical damage of the unit.
- Re-place the cover on the camera when the terminal is not in use.

DI-GPS® IS A REGISTERED TRADEMARK OR A TRADEMARK OF DAWN TECHNOLOGY LIMITED.

NIKON D5, D4, D4S, D3, D3S, D3X, D500, D810A, D810, D800, D800E, D700, D300, D300S, D2XS, D2X, D2HS, D200, D5600, D3400, D7200, D5500, D3300, DF, D5300, D610, D600, D750, D7100, D7000, D5100, D5000, D3200, D3100, D90 ARE REGISTERED TRADEMARK OR A TRADEMARK OF NIKON CORPORATION IN THE UNITED STATES AND/OR OTHER COUNTRIES.

FUJIFILM AND S5 PRO ARE REGISTERED TRADEMARK OR A TRADEMARK OF FUJIFILM U.S.A., INC. IN THE UNITED STATES AND/OR OTHER COUNTRIES.

V1.3

POWER SUPPLY

ECO PF-2 GPS is not equipped with battery. Power of the GPS is supplied by the camera's battery via the 10-pin connector.

POWER MODE BUTTON

Connect ECO PF-2 GPS to the camera and turn the camera on. The default power mode is set to Auto Mode.

Press the **Power mode button** to switch between **Always-On Mode** and **Auto Mode**.

Auto Mode: The GPS is switched on or off with the camera generally. If the function, **Auto Meter Off** or **Standby time** ⁽¹⁾ on the camera is enabled, the GPS goes off when the exposure meters of the camera turn off automatically according to the time set ⁽²⁾.

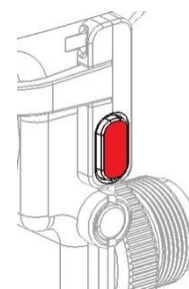



Always-On Mode: The GPS is steadily on regardless of whether the camera is on or off. This can prevent the GPS receiver from deactivating with the camera or the exposure meters to allow a continuous reception of GPS data. The device is immediately ready for shooting photos with GPS data as the camera is turned on again.

Remark

(1) Auto Meter Off is available for D4, D3, D3S, D3X, D800, D800E, D700, D300 and D300S.
Standby time is available for D5, D4S, D500, D810A, D810 and D850.
This function is not applicable in D2XS, D2X, D2HS, D200 and Fujifilm S5 Pro.

(2) The time set is specified in Custom Setting c2 of the camera.

Power mode LED	DESCRIPTION
 Off	<ul style="list-style-type: none">• Auto Mode
 Red LED On	<ul style="list-style-type: none">• Always-On Mode

DI-GPS® IS A REGISTERED TRADEMARK OR A TRADEMARK OF DAWN TECHNOLOGY LIMITED.

NIKON D5, D4, D4S, D3, D3S, D3X, D500, D810A, D810, D800, D800E, D700, D300, D300S, D2XS, D2X, D2HS, D200 D5600, D3400, D7200, D5500, D3300, DF, D5300, D610, D600, D750, D7100, D7000, D5100, D5000, D3200, D3100, D90 ARE REGISTERED TRADEMARK OR A TRADEMARK OF NIKON CORPORATION IN THE UNITED STATES AND/OR OTHER COUNTRIES.

FUJIFILM AND S5 PRO ARE REGISTERED TRADEMARK OR A TRADEMARK OF FUJIFILM U.S.A., INC. IN THE UNITED STATES AND/OR OTHER COUNTRIES.





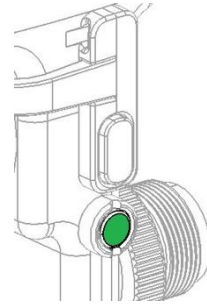

RECORDING GPS DATA (I)

Connect ECO PF-2 GPS to the camera and turn the camera on.

If ECO PF-2 GPS is properly connected, the LED of ECO PF-2 GPS will start blinking and a **GPS** icon will be shown in the top control panel / on the LCD monitor. The blinking LED means that the GPS receiver is searching for a signal.

The **GPS** icon will stop blinking once signal has been established and the camera is ready to record the current position.



STATUS LED (on GPS)	GPS ICON (on camera)	DESCRIPTION
 Blinks	 Blinking Icon	<ul style="list-style-type: none"> • No fix, Signal searching • No Last Position Memory output • No GPS data will be recorded in the photos
 Blinks	 Icon Steady	<ul style="list-style-type: none"> • No fix, Signal searching • Last Position Memory output with current UTC date/time to the camera until new fix is available • Last fixed GPS position will be recorded to the photos
 Steady On	 Icon Steady	<ul style="list-style-type: none"> • Fix available • ECO PF-2 GPS continuously sends the current GPS position to the camera.

NOTE

- LED on ECO PF-2 GPS only represents the status of ECO PF-2 GPS but not the reception of GPS data to the camera.
- GPS data is only recorded when **GPS** icon is shown in the top control panel / on the LCD monitor of DSLR camera. Please make sure that the **GPS** icon is displayed before shooting.

DI-GPS® IS A REGISTERED TRADEMARK OR A TRADEMARK OF DAWN TECHNOLOGY LIMITED.
 NIKON D5, D4, D4S, D3, D3S, D3X, D500, D810A, D810, D800, D800E, D700, D300, D300S, D2XS, D2X, D2HS, D200, D5600, D3400, D7200, D5500, D3300, DF, D5300, D610, D600, D750, D7100, D7000, D5100, D5000, D3200, D3100, D90 ARE REGISTERED TRADEMARK OR A TRADEMARK OF NIKON CORPORATION IN THE UNITED STATES AND/OR OTHER COUNTRIES.
 FUJIFILM AND S5 PRO ARE REGISTERED TRADEMARK OR A TRADEMARK OF FUJIFILM U.S.A., INC. IN THE UNITED STATES AND/OR OTHER COUNTRIES.

RECORDING GPS DATA (II)

Each satellite broadcasts a digital message that contains two types of information. The first type is ephemeris data, which includes the assigned serial number of the satellite, the status of the satellite (healthy or faulty) and the current date and time. The other type is almanac data and it includes precise orbital position of every satellite in the system.

At the initial stage, ECO PF-2 GPS needs all these data for position fixing. It usually takes a minute to a few to receive all data. An open sky outdoor environment will enable faster data acquisition while a longer time will be required under an environment with weak signals. By introducing the **EASY™** function in ECO PF-2 GPS, time needed for reacquisition of data is shortened to only a few seconds even in weak-signal environment once the GPS receiver is locked to the satellite.

EASY™ stands for Embedded Assist System, which is a function for quick positioning. ECO PF-2 GPS will calculate and automatically predict the single emperies (up to 3 days) when it is turned on. Predicted information is saved into memory and used for positioning if not enough information is obtained from the satellites. This can tremendously improve the receiver's positioning performance in weak-signal environment.

For the **EASY™** function to work properly, the ECO PF-2 GPS will need to collect enough information from the satellites beforehand, which will take less than 2 minutes. Please let the GPS on for **1-2 minutes** after the first fix **during the first use or after not using for 3 days** to allow collection of all necessary data from the satellites.

As power is needed to sustain the internal memory, ECO PF-2 GPS should be connected to the camera **at all times** to prevent the loss of ephemeris data. Memory backup capacitor in ECO PF-2 GPS can provide about two-minute power to the internal memory during short disconnection from camera or changing of camera battery. Consuming only a very small amount of energy, the internal memory will not affect the battery life of the camera.

DI-GPS® IS A REGISTERED TRADEMARK OR A TRADEMARK OF DAWN TECHNOLOGY LIMITED.

NIKON D5, D4, D4S, D3, D3S, D3X, D500, D810A, D810, D800, D800E, D700, D300, D300S, D2XS, D2X, D2HS, D200, D5600, D3400, D7200, D5500, D3300, DF, D5300, D610, D600, D750, D7100, D7000, D5100, D5000, D3200, D3100, D90 ARE REGISTERED TRADEMARK OR A TRADEMARK OF NIKON CORPORATION IN THE UNITED STATES AND/OR OTHER COUNTRIES.

FUJIFILM AND S5 PRO ARE REGISTERED TRADEMARK OR A TRADEMARK OF FUJIFILM U.S.A., INC. IN THE UNITED STATES AND/OR OTHER COUNTRIES.

LAST POSITION MEMORY (LPM)

ECO PF-2 GPS is able to provide the **last known GPS position with current UTC date / time** to the DSLR camera even if GPS signal is lost or the unit is out of the GPS coverage.

- **No fix** will be reported when there is no GPS position. The camera's GPS icon will flash and no GPS data will be recorded.
- **A first fix** is needed during initialization before the LPR can function properly.
- Current GPS position will be reported to the camera immediately once new fix is available.
- Last known GPS position with current UTC date / time will be continuously reported even when the GPS signal is lost, the unit is out of GPS coverage, until there is a good position fix.
- Last known position will be saved to internal memory every 5 seconds. The GPS unit is equipped with built-in power backup capacitor that provides about two-minute power to the internal memory / internal clock running after disconnection from camera or during changing of camera battery. When the power of internal capacitor is exhausted, the GPS unit will no longer report its position. The camera's GPS icon will flash and no GPS data will be recorded.

DI-GPS® IS A REGISTERED TRADEMARK OR A TRADEMARK OF DAWN TECHNOLOGY LIMITED.

NIKON D5, D4, D4S, D3, D3S, D3X, D500, D810A, D810, D800, D800E, D700, D300, D300S, D2XS, D2X, D2HS, D200, D5600, D3400, D7200, D5500, D3300, DF, D5300, D610, D600, D750, D7100, D7000, D5100, D5000, D3200, D3100, D90 ARE REGISTERED TRADEMARK OR A TRADEMARK OF NIKON CORPORATION IN THE UNITED STATES AND/OR OTHER COUNTRIES.

FUJIFILM AND S5 PRO ARE REGISTERED TRADEMARK OR A TRADEMARK OF FUJIFILM U.S.A., INC. IN THE UNITED STATES AND/OR OTHER COUNTRIES.

V1.3

SPECIFICATIONS

General	Chipset MTK MT3339 Frequency L1, 1575.42 MHz C/A code 1.023 MHz chip rate Channels 66 channels all-in-view tracking
Sensitivity	Acquisition -148dBm (Cold Start), -165 dBm tracking
Accuracy (Open Sky)	Position Without aid 10 meters (50% CEP) DGPS (SBAS, WAAS, EGNOS, MASA) 5 meters (50% CEP) Velocity 0.1 m/s Time 1 μ s synchronized to GPS time
Datum	WGS-84
Acquisition Time (Open sky, stationary requirements)	Reacquisition in less than 1 sec., average Hot start 1 sec., average Warm start 33 sec., average Cold start 35 sec., average (No. of SVs > 4, C/N > 40dB, PDop < 1.5)
Dynamic Conditions	Altitude: Maximum 18,000m Velocity: Maximum 515 m/s Acceleration: Maximum 4G
Power Source	Powered from DSLR camera via 10-pin connector Current consumption: 19mA acquisition, 17mA tracking
Protocol	Baud rate 4,800 bps Output message NMEA 0183
Interface	Nikon 10-pin connector (direct connection to Nikon DSLR cameras)
Physical Characteristics	Dimension: 42mm*22mm*21mm Weight: 18g Operating Temperature: -10°C to +45°C Operating Humidity: 5% to 90%, No Condensing

DI-GPS® IS A REGISTERED TRADEMARK OR A TRADEMARK OF DAWN TECHNOLOGY LIMITED.

NIKON D5, D4, D4S, D3, D3S, D3X, D500, D810A, D810, D800, D800E, D700, D300, D300S, D2XS, D2X, D2HS, D200 D5600, D3400, D7200, D5500, D3300, DF, D5300, D610, D600, D750, D7100, D7000, D5100, D5000, D3200, D3100, D90 ARE REGISTERED TRADEMARK OR A TRADEMARK OF NIKON CORPORATION IN THE UNITED STATES AND/OR OTHER COUNTRIES.

FUJIFILM AND S5 PRO ARE REGISTERED TRADEMARK OR A TRADEMARK OF FUJIFILM U.S.A., INC. IN THE UNITED STATES AND/OR OTHER COUNTRIES.

V1.3

WARRANTY

- Dawn Technology Limited guarantees its product which is determined to be defective or faulty materials and workmanship for a period of one year after the date of purchase. During the one-year warranty, Dawn Technology will repair or replace the product free of charges. Please keep your original invoice as proof of purchase.
- Customers who have product covered under the warranty are required to contact Dawn Technology Limited by e-mail for troubleshooting issues before returning the product.
- Customers are responsible for shipping and insurance charges for returning the product to Dawn Technology Limited.
- Charges will be imposed for repairing products which are out of warranty coverage or without valid warranty.
- The guarantee is not valid if the defect is due to damage caused by incorrect usage, poor maintenance or if alterations or repairs have been carried out by persons not authorized by Dawn Technology Limited.
- To use the device correctly, users should strictly adhere to all instructions included in the user guide and abstain from any actions or uses that are described as undesired or are warned against in the user guide.

DI-GPS® IS A REGISTERED TRADEMARK OR A TRADEMARK OF DAWN TECHNOLOGY LIMITED.

NIKON D5, D4, D4S, D3, D3S, D3X, D500, D810A, D810, D800, D800E, D700, D300, D300S, D2XS, D2X, D2HS, D200, D5600, D3400, D7200, D5500, D3300, DF, D5300, D610, D600, D750, D7100, D7000, D5100, D5000, D3200, D3100, D90 ARE REGISTERED TRADEMARK OR A TRADEMARK OF NIKON CORPORATION IN THE UNITED STATES AND/OR OTHER COUNTRIES.

FUJIFILM AND S5 PRO ARE REGISTERED TRADEMARK OR A TRADEMARK OF FUJIFILM U.S.A., INC. IN THE UNITED STATES AND/OR OTHER COUNTRIES.

V1.3

EUROPEAN UNION DECLARATION OF CONFORMITY

Hereby, Dawn Technology Limited declares that the radio equipment type PF-2/PF-2DC is in compliance with Directive 2014/53/EU. The full text of the EU declaration of conformity is available at the following internet address: <http://www.di-gps.com/ce/2017/index.html>



български (BG)

С настоящото Dawn Technology Limited декларира, че този тип радиосъоръжение PF-2/PF-2DC е в съответствие с Директива 2014/53/ЕС. Цялостният текст на ЕС декларацията за съответствие може да се намери на следния интернет адрес: <http://www.di-gps.com/ce/2017/index.html>

Español(ES)

Por la presente, Dawn Technology Limited declara que el tipo de equipo radioeléctrico PF-2/PF-2DC es conforme con la Directiva 2014/53/UE. El texto completo de la declaración UE de conformidad está disponible en la dirección Internet siguiente: <http://www.di-gps.com/ce/2017/index.html>

Čeština (CS)

Tímto Dawn Technology Limited prohlašuje, že typ rádiového zařízení PF-2/PF-2DC je v souladu se směrnicí 2014/53/EU. Úplné znění EU prohlášení o shodě je k dispozici na této internetové adrese: <http://www.di-gps.com/ce/2017/index.html>

Dansk (DA)

Hermed erklærer Dawn Technology Limited, at radioudstyrstypen PF-2/PF-2DC er i overensstemmelse med direktiv 2014/53/EU. EU-overensstemmelseserklæringens fulde tekst kan findes på følgende internetadresse: <http://www.di-gps.com/ce/2017/index.html>

Deutsch (DE)

Hiermit erklärt Dawn Technology Limited, dass der Funkanlagentyp PF-2/PF-2DC der Richtlinie 2014/53/EU entspricht. Der vollständige Text der EU-Konformitätserklärung ist unter der folgenden Internetadresse verfügbar: <http://www.di-gps.com/ce/2017/index.html>

Eesti (ET)

Käesolevaga deklareerib Dawn Technology Limited, et käesolev raadioseadme tüüp PF-2/PF-2DC vastab direktiivi 2014/53/EL nõuetele. Eli vastavusdeklaratsiooni täielik tekst on kättesaadav järgmisel internetiaadressil: <http://www.di-gps.com/ce/2017/index.html>

Ελληνικά (EL)

Με την παρούσα ο/η Dawn Technology Limited, δηλώνει ότι ο ραδιοεξοπλισμός PF-2/PF-2DC πληροί την οδηγία 2014/53/ΕΕ. Το πλήρες κείμενο της δήλωσης συμμόρφωσης ΕΕ διατίθεται στην ακόλουθη ιστοσελίδα στο διαδίκτυο: <http://www.di-gps.com/ce/2017/index.html>

Français (FR)

Le soussigné, Dawn Technology Limited, déclare que l'équipement radioélectrique du type PF-2/PF-2DC est conforme à la directive 2014/53/UE. Le texte complet de la déclaration UE de conformité est disponible à l'adresse internet suivante: <http://www.di-gps.com/ce/2017/index.html>

Hrvatski (HR)

Dawn Technology Limited ovime izjavljuje da je radijska oprema tipa PF-2/PF-2DC u skladu s Direktivom 2014/53/EU. Cjeloviti tekst EU izjave o sukladnosti dostupan je na sljedećoj internetskoj adresi: <http://www.di-gps.com/ce/2017/index.html>

Italiano (IT)

Il fabbricante, Dawn Technology Limited, dichiara che il tipo di apparecchiatura radio PF-2/PF-2DC è conforme alla direttiva 2014/53/UE. Il testo completo della dichiarazione di conformità UE è disponibile al seguente indirizzo Internet: <http://www.di-gps.com/ce/2017/index.html>

Latviešu (LV)

Ar šo Dawn Technology Limited deklarē, ka radioiekārta PF-2/PF-2DC atbilst Direktīvai 2014/53/ES. Pilns ES atbilstības deklarācijas teksts ir pieejams šādā interneta vietnē: <http://www.di-gps.com/ce/2017/index.html>

DI-GPS® IS A REGISTERED TRADEMARK OR A TRADEMARK OF DAWN TECHNOLOGY LIMITED.

NIKON D5, D4, D4S, D3, D3S, D3X, D500, D810A, D810, D800, D800E, D700, D300, D300S, D2XS, D2X, D2HS, D200 D5600, D3400, D7200, D5500, D3300, DF, D5300, D610, D600, D750, D7100, D7000, D5100, D5000, D3200, D3100, D90 ARE REGISTERED TRADEMARK OR A TRADEMARK OF NIKON CORPORATION IN THE UNITED STATES AND/OR OTHER COUNTRIES.

FUJIFILM AND S5 PRO ARE REGISTERED TRADEMARK OR A TRADEMARK OF FUJIFILM U.S.A., INC. IN THE UNITED STATES AND/OR OTHER COUNTRIES.

V1.3

EUROPEAN UNION DECLARATION OF CONFORMITY (II)

Lietuvių (LT)

Aš, Dawn Technology Limited, patvirtinu, kad radijo įrenginių tipas PF-2/PF-2DC atitinka Direktyvą 2014/53/ES. Visas ES atitikties deklaracijos tekstas prieinamas šiuo interneto adresu: <http://www.di-gps.com/ce/2017/index.html>

Magyar (HU)

Dawn Technology Limited igazolja, hogy a PF-2/PF-2DC típusú rádióberendezés megfelel a 2014/53/EU irányelvnek. Az EU-megfelelőségi nyilatkozat teljes szövege elérhető a következő internetes címen: <http://www.di-gps.com/ce/2017/index.html>

Malti (MT)

B'dan, Dawn Technology Limited, niddikjara li dan it-tip ta' tagħmir tar-radju PF-2/PF-2DC huwa konformi mad-Direttiva 2014/53/UE. It-test kollu tad-dikjarazzjoni ta' konformità tal-UE huwa disponibbli f'dan l-indirizz tal-Internet li ġej: <http://www.di-gps.com/ce/2017/index.html>

Nederlands (NL)

Hierbij verklaar ik, Dawn Technology Limited, dat het type radioapparatuur PF-2/PF-2DC conform is met Richtlijn 2014/53/EU. De volledige tekst van de EU-conformiteitsverklaring kan worden geraadpleegd op het volgende internetadres: <http://www.di-gps.com/ce/2017/index.html>

Polski (PL)

Dawn Technology Limited niniejszym oświadcza, że typ urządzenia radiowego PF-2/PF-2DC jest zgodny z dyrektywą 2014/53/UE. Pełny tekst deklaracji zgodności UE jest dostępny pod następującym adresem internetowym: <http://www.di-gps.com/ce/2017/index.html>

Português (PT)

O(a) abaixo assinado(a) Dawn Technology Limited declara que o presente tipo de equipamento de rádio PF-2/PF-2DC está em conformidade com a Diretiva 2014/53/UE. O texto integral da declaração de conformidade está disponível no seguinte endereço de Internet: <http://www.di-gps.com/ce/2017/index.html>

Română (RO)

Prin prezenta, Dawn Technology Limited declară că tipul de echipamente radio PF-2/PF-2DC este în conformitate cu Directiva 2014/53/UE. Textul integral al declarației UE de conformitate este disponibil la următoarea adresă internet: <http://www.di-gps.com/ce/2017/index.html>

Slovensky (SK)

Dawn Technology Limited týmto vyhlasuje, že rádiové zariadenie typu PF-2/PF-2DC je v súlade so smernicou 2014/53/EÚ. Úplné EÚ vyhlásenie o zhode je k dispozícii na tejto internetovej adrese: <http://www.di-gps.com/ce/2017/index.html>

Slovensko (SL)

Dawn Technology Limited potrjuje, da je tip radijske opreme PF-2/PF-2DC skladen z Direktivo 2014/53/EU. Celotno besedilo izjave EU o skladnosti je na voljo na naslednjem spletnem naslovu: <http://www.di-gps.com/ce/2017/index.html>

Suomi (FI)

Dawn Technology Limited vakuuttaa, että radiolaitetyypit PF-2/PF-2DC on direktiivin 2014/53/EU mukainen. EU-vaatimustenmukaisuusvakuutuksen täysimittainen teksti on saatavilla seuraavassa internetosoitteessa: <http://www.di-gps.com/ce/2017/index.html>

Svenska (SV)

Härmed försäkrar Dawn Technology Limited att denna typ av radioutrustning PF-2/PF-2DC överensstämmer med direktiv 2014/53/EU. Den fullständiga texten till EU-försäkran om överensstämmelse finns på följande webbadress: <http://www.di-gps.com/ce/2017/index.html>

Information in this document is subject to change without notice. Dawn Technology Limited reserves the right to change or improve their products and to make changes in the content without the obligation to notify any person or organization of such changes or improvements.

DI-GPS® IS A REGISTERED TRADEMARK OR A TRADEMARK OF DAWN TECHNOLOGY LIMITED.

NIKON D5, D4, D4S, D3, D3S, D3X, D500, D810A, D810, D800, D800E, D700, D300, D300S, D2XS, D2X, D2HS, D200 D5600, D3400, D7200, D5500, D3300, DF, D5300, D610, D600, D750, D7100, D7000, D5100, D5000, D3200, D3100, D90 ARE REGISTERED TRADEMARK OR A TRADEMARK OF NIKON CORPORATION IN THE UNITED STATES AND/OR OTHER COUNTRIES.

FUJIFILM AND S5 PRO ARE REGISTERED TRADEMARK OR A TRADEMARK OF FUJIFILM U.S.A., INC. IN THE UNITED STATES AND/OR OTHER COUNTRIES.

V1.3